



M-POWER-4T

AC POWER & DATA CONNECTIVITY SOLUTION

M-POWER-4TW-MVD-SNSTP

Distributed by



Mormax Company, Inc.

8 Westchester Plaza

Elmsford, NY 10523

914-699-0101

sales@mormax.com

mormax.com

Metro Light & Power's line of power & data solutions offers sophisticated design elements combined with greater ease of installation. Streamlined and low-profile, enhanced by side-exiting cords, our outlets advance the industry with their cutting edge look and feel. We believe flexibility is key, and we provide a variety of mounting options, including the ability to mount in limited spaces. Our outlets are available in many finishes and configurations, in addition to a custom color and finish capability for our clients.

Trim Plate Finish: **SATIN NICKEL (ZINC/STEEL)**

Custom Finishes Available

M-POWER-4TW-MVD-SNSTP

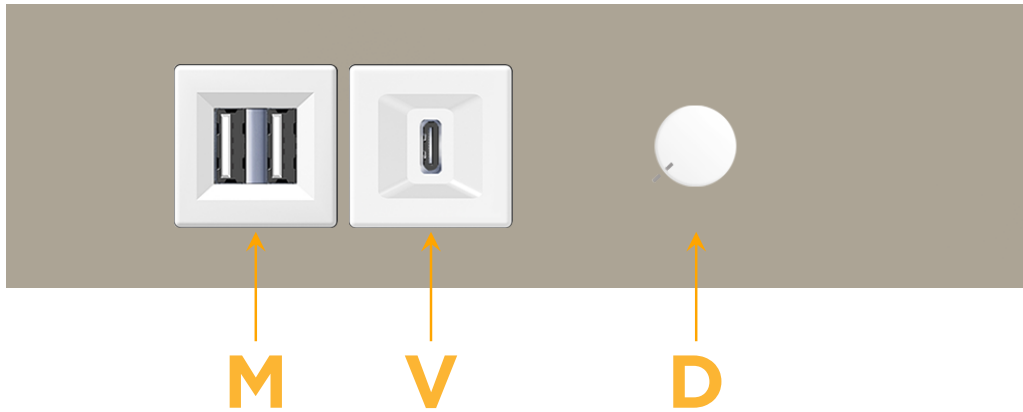

Features:

Module/Port Options:

- A** Tamper Resistant AC Receptacle
- E** USB-A & USB-C (20W)
- M** Double USB-A (Fast Charging Ports - 18W)
- H** HDMI
- 6** CAT 6
- 12** RJ 12
- X** Switched AC
- Y** 3-Way Switch (Low Voltage)
- V** USB-C (45W High Speed Charging Port)
- S** USB-C (25W High Speed Charging Port)
- R** Switched AC (Rocker Switch)
- D** Dimmer Switch

Plug:

Supplied with Low Profile Flat 45° Angle 120 VAC Plug

Optional Standard Straight 120 VAC Plug

Optional Straight 120 VAC Pass-through Plug

- CLEAN, COMPACT DESIGN
- STREAMLINED
- LOW PROFILE
- SIDE-EXITING CORDS
- PLUG & PLAY
- 6' AC CORD & PLUG (FLAT PLUG STANDARD)
- CUSTOMIZABLE CONFIGURATIONS AND FINISHES
- ETL LISTED FOR MOUNTING IN FURNITURE
- 15A





M-POWER-4T

AC POWER & DATA CONNECTIVITY SOLUTION

M-POWER-4TW-MVD-SNSTP

Specs:

Modules/Ports:

- M** Double USB-A (Fast Charging Ports - 18W)
- V** USB-C (45W High Speed Charging Port)
- D** Dimmer Switch

M V D

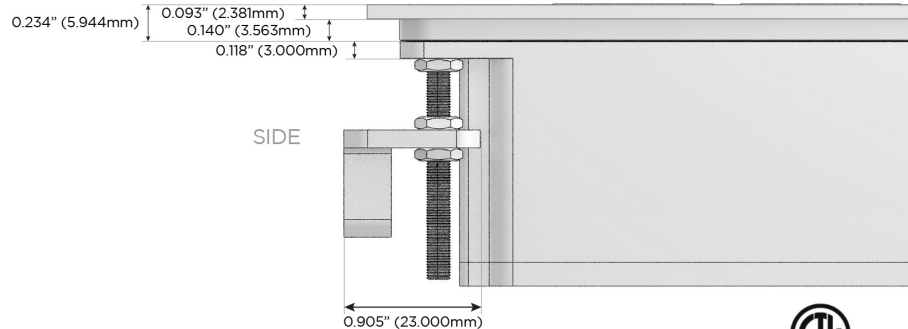
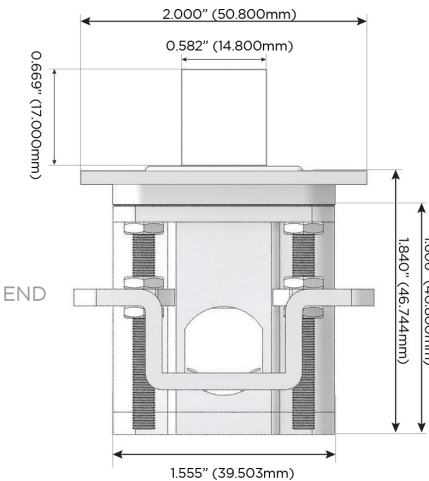
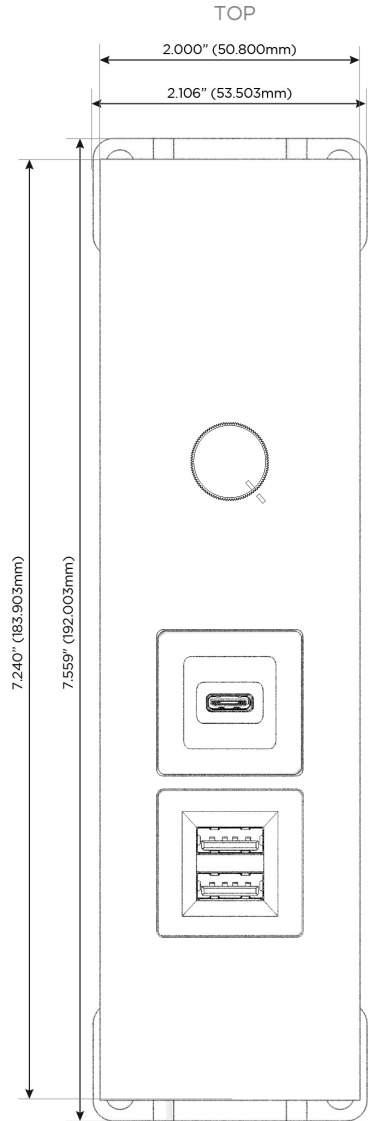
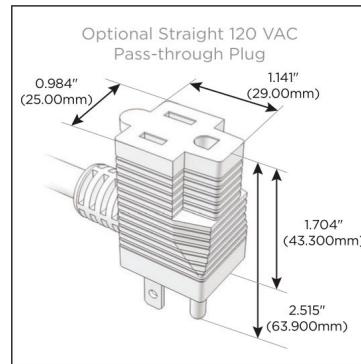
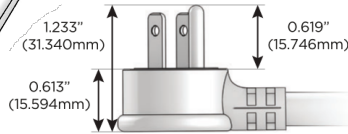
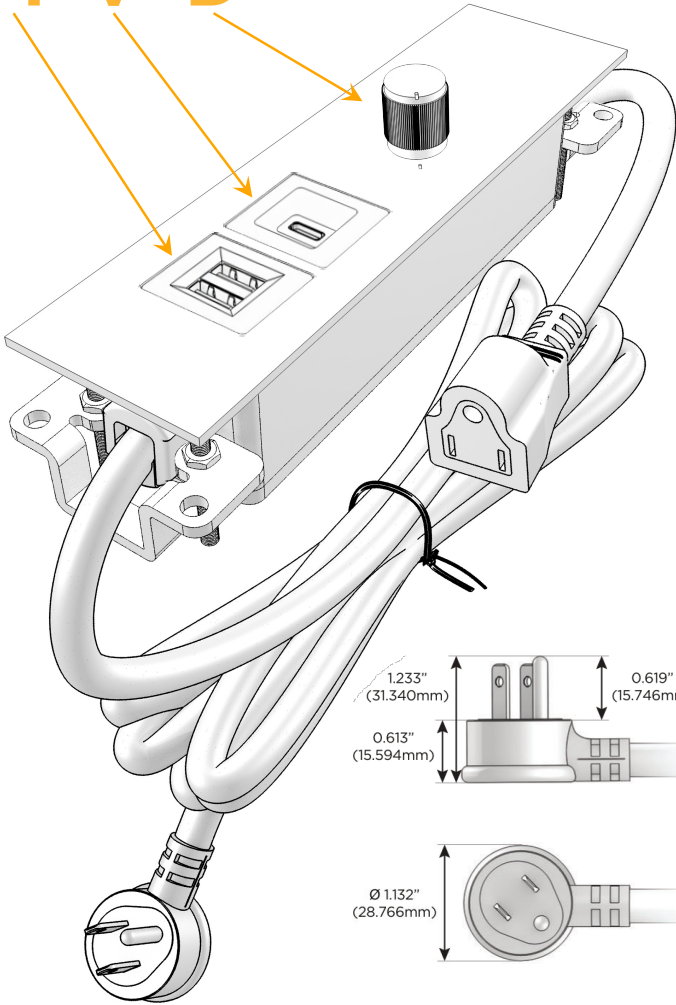

Distributed by



Mormax Company, Inc.

8 Westchester Plaza

Elmsford, NY 10523

914-699-0101

sales@mormax.com

mormax.com

