



M-POWER-4T

AC POWER & DATA CONNECTIVITY SOLUTION

M-POWER-4T-ABD-BZSTP-ADA

Distributed by



Mormax Company, Inc. 914-699-0101

8 Westchester Plaza sales@mormax.com

Elmsford, NY 10523 mormax.com

Metro Light & Power's line of power & data solutions offers sophisticated design elements combined with greater ease of installation. Streamlined and low-profile, enhanced by side-exiting cords, our outlets advance the industry with their cutting edge look and feel. We believe flexibility is key, and we provide a variety of mounting options, including the ability to mount in limited spaces. Our outlets are available in many finishes and configurations, in addition to a custom color and finish capability for our clients.

Trim Plate Finish: **STANDARD BRONZE (STEEL)**

Custom Finishes Available

M-POWER-4T-ABD-BZSTP-ADA

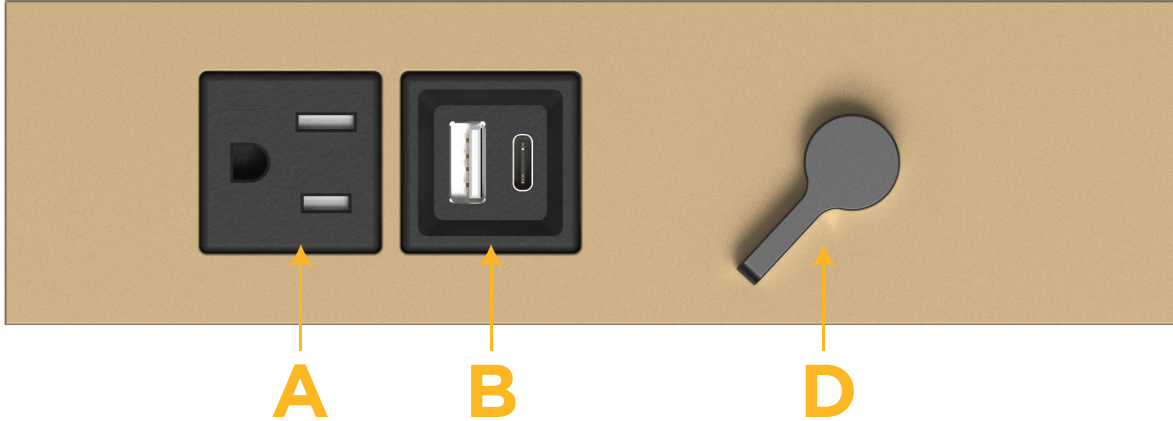

Features:

Module/Port Options:

- A Tamper Resistant AC Receptacle
- B USB-A & USB-C (3.0A USB-A / 15W USB-C)
- U Double USB-A (Fast Charging Ports - Rated for 3.2A)
- H HDMI
- 6 CAT 6
- 12 RJ 12
- X Switched AC
- Y 3-Way Switch (Low Voltage)
- C USB-C (27W High Speed Charging Port)
- Z USB-C (18W High Speed Charging Port)
- R Switched AC (Rocker Switch)
- D Dimmer Swith (ADA Compliant Knob)

Plug:

Supplied with Low Profile Flat 45° Angle 120 VAC Plug

Optional Standard Straight 120 VAC Plug

Optional Straight 120 VAC Pass-through Plug

- CLEAN, COMPACT DESIGN
- STREAMLINED
- LOW PROFILE
- SIDE-EXITING CORDS
- PLUG & PLAY
- 3.0A USB-A / 15W USB-C HIGH SPEED CHARGING FOR ALL DEVICES
- 6' AC CORD & PLUG (FLAT PLUG STANDARD)
- CUSTOMIZABLE CONFIGURATIONS AND FINISHES
- ETL LISTED (IN COMPLIANCE WITH UL 962A)
- 15A
- ADA COMPLIANT KNOB
- 0% TO 100% DIMMING



M-POWER-4T

AC POWER & DATA CONNECTIVITY SOLUTION

M-POWER-4T-ABD-BZSTP-ADA

Specs:

Modules/Ports:

- A** Tamper Resistant AC Receptacle
- B** USB-A & USB-C (3.0A USB-A / 15W USB-C)
- D** Dimmer Switch (ADA Compliant Knob)

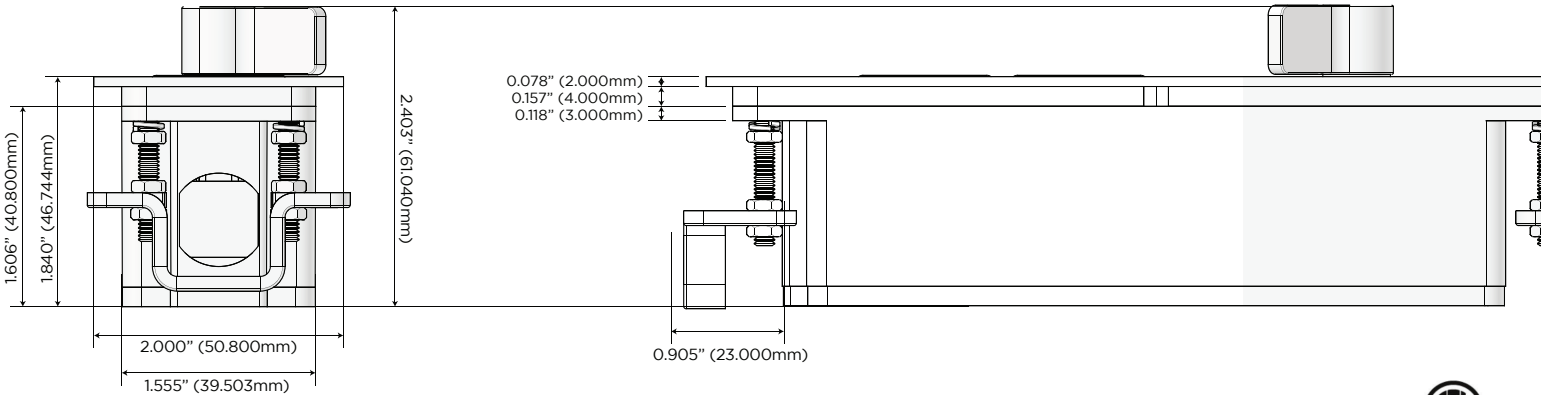
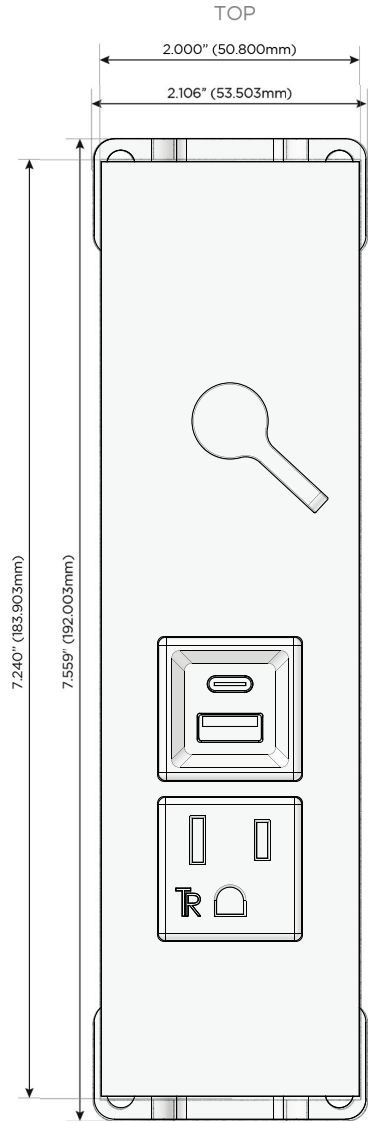
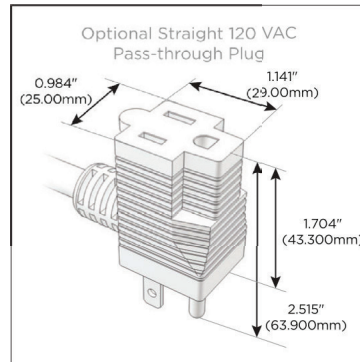
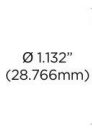
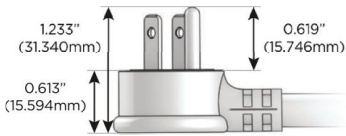
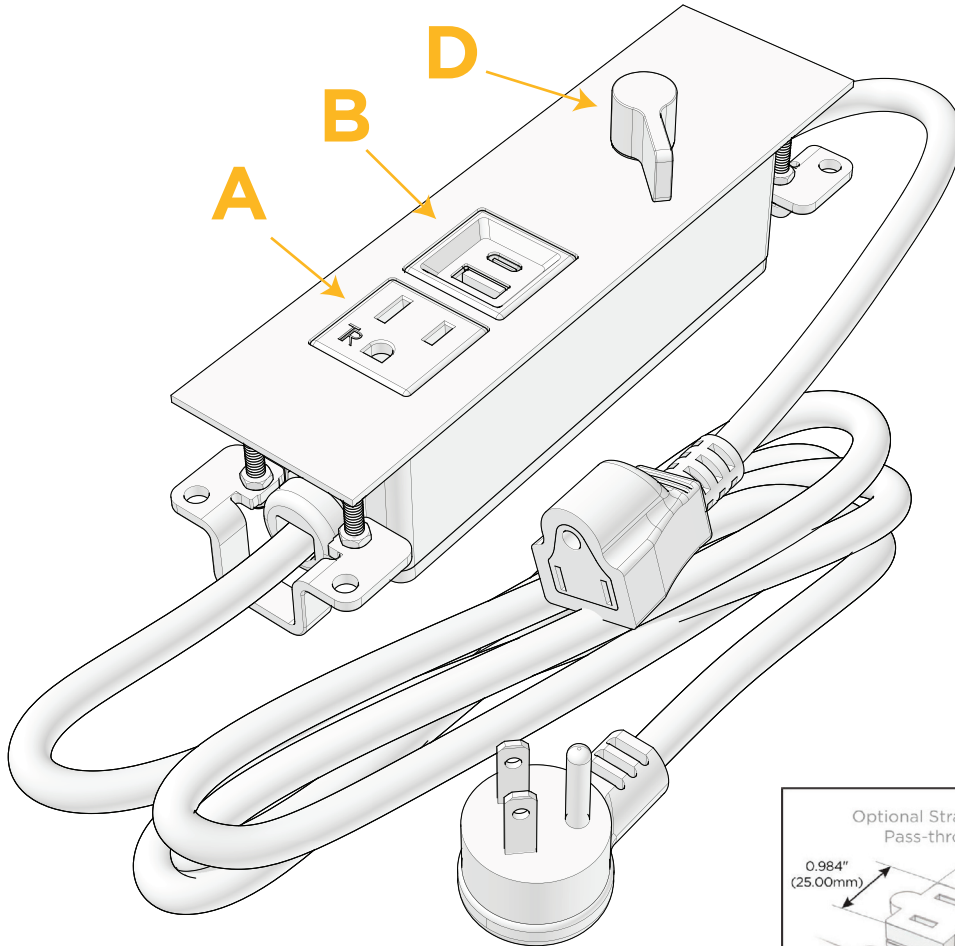

Distributed by



Mormax Company, Inc. 914-699-0101

8 Westchester Plaza sales@mormax.com

Elmsford, NY 10523 mormax.com

